

office
master
Work Happy

acoustic pods





WinPod for the win

WINPOD 2.0 pairs finely crafted aesthetics with sustainable materials to protect our mother earth. Its sound insulation effects have been tested by international certification organisation, reflecting WINPOD's ingenuity and WINTECH's endeavour in creating a workspace that improves productivity and privacy.

In an environment with sound level is above 70 dB, you will soon find yourself difficult to remain focused and productive at work. WINPOD 2.0 has gone through rigorous test based on ISO 23351-1 standards, with the speech level reduction at 28.3 dB. It creates a serene and relaxing environment that counters the stress and anxiety of our daily grinds. WINPOD 2.0 not only provides more opportunities for creative collaboration, but also helps to maximize users' concentration and satisfaction, as well as enjoy the quiet moment.

Aside from sound insulation, WINPOD 2.0 has achieved GREENGUARD Certification which is scientifically proven to meet some of the world's most rigorous third-party chemical emissions standards, helping to reduce indoor air pollution and the risk of chemical exposure. The certification can contribute to LEED credits as well.

WinPod features

Air Purifying System with HEPA Filter. The pod is well ventilated with filtered air to provide a comfortable and clean workspace to the user.

Motion Sensor for Energy Saving. LED lighting and air ventilation system are activated by the motion sensor, and will be automatically turned off after 5 minutes of inactivity.

Ergonomic and Exclusive Charging Ports. CE certified charging ports with AC outlet, type A / type C 45W PD and CAT6 port. Input 110-240 VAC, 10A, 50-60Hz.

Acoustic Material for Sound Insulation. The speech level reduction in the pod offers private and quiet environment, to be free from disturbances.

Auto Close Tempered Glass Door. The door can only be opened up to 95° to prevent collision against surroundings.

Elegant Door Handle. Trendy and aesthetic designs making WINPOD 2.0 an elegant component to the surroundings.

Knockout Hole for Sprinkler. Sprinkler head can be installed based on safety requirement.

Castors for The Ease of Mobility. An add-on feature for S/W/D POD 2.0. *Optional

Quick And Easy To Assemble. Improved design which makes installation time possible within 30 minutes.

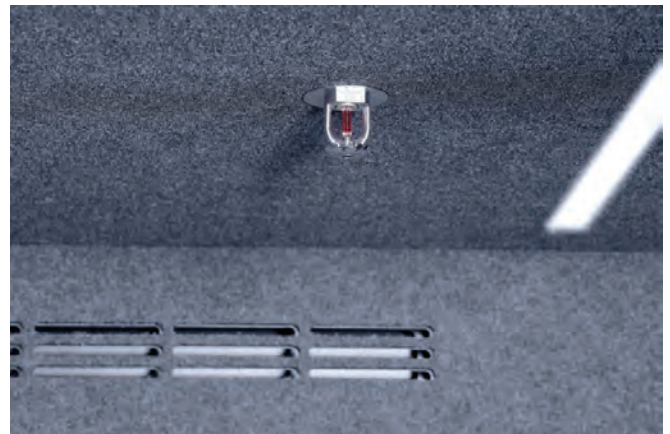

Clockwise L-R: Elegant door handle; ceiling features a knock-out hole for a sprinkler, LED light and ventilation holes; panel features a dimmer switch, USB and C charging points and AC outlet.

S Pod 2.0

S POD 2.0 is a classic pod for single person. In the serene space, an individual can carry out works that require high level of privacy such as signing contracts, making phone calls, and video conference.

* High stool not included.

1. Laminated Desktop
2. Castor *Optional
3. Power Consumption: 0.18 A
4. Net Weight: 278 kg



W Pod 2.0

W POD 2.0 has a unique extendable desktop with multiple functions. This ergonomic feature allows you to adjust your working position, while providing a storage space. This spacious pod is suitable for individual who wants to work over a long period of time.



1. Extendable Desktop With Storage Space
2. Exclusive Design Of Sofa With Backrest
3. Castor *Optional
4. Power Consumption: 0.18 A
5. Net Weight: 405 kg



D Pod 2.0

D POD 2.0 can accommodate two to four persons. The sofas come with comfortable backrest allow users to carry out discussions in a relaxed manner, most importantly free from disturbance. Aiming to achieve satisfaction and better results.

1. Laminated Desktop
2. Exclusive Design Of Sofa With Backrest
3. Castor *Optional
4. Power Consumption: 0.33 A
5. Net Weight: 532 kg

C Pod 2.0

C POD 2.0 is designed to fit up to five people, ideally for meeting, entertainment or relaxing. The meeting table with integrated charging ports are perfect for discussion and brainstorming.

Choice of L-shaped sofa offers a casual yet private moments for users.

* Side table and TV not included

1. Selections Of Furnishing:

- Exclusive L-Shaped Sofa
- Meeting Table With Integrated Charging Ports
- Bare Unit

2. TV Bracket With AC Power Socket*

3. Power Consumption: 0.47 A

4. Net Weight: 893 kg

*Optional





M Pod 2.0

M POD 2.0 can accommodate up to seven persons. Its comfortable and well-ventilated space can help users to increase work efficiency and productivity.

Apart from the meeting table and L-shaped sofa, a bare unit is also available for your personal option to furnish it.

*Chairs and TV not included

1. Selections Of Furnishing:

- Exclusive L-Shaped Sofa
- Meeting Table With Integrated Charging Ports
- Bare Unit

2. TV Bracket With AC Power Socket*

3. Power Consumption: 0.47 A

4. Net Weight: 967 kg

*Optional



zen pod[®]
by abstracta



Zen Pod® by abstracta

Zen Pods are more than merely a retreat, a place to catch one's breath. More than just peace and quiet. It is a space to be enjoyed — elegantly and sparingly designed using welcoming, sympathetic materials such as wood, wool, glass, aluminium and steel.

“Zen Pod is a smart quiet room range equipped with plenty of functionality — and nothing superfluous.”

Zen Pod is available in two versions: 'Essential' and 'Advanced'. Both feature a mix of excellent materials, state-of-the-art lighting and ventilation, and both have been designed with careful attention to detail, as well as overall appearance.

Zen Pod comes in several sizes; Small, Medium, Large, X-Large and XX-Large.

Designed by Staffan Holm, Zen Pod is for spaces where people often meet and move about — whether in a university, a hospital, or a modern office complex.

Zen Pod is an acoustic oasis. It creates the perfect conditions for digital meetings, quiet conversations and focused work. Its outer acoustic walls also help to improve the soundscape of the surrounding environment by absorbing, rather than reflecting, ambient noise.

Advanced features

Exceptional acoustic performance. Zen Pod dampens sound by 31 dB, which means that it achieves sound attenuation class A.

Everything you need. Power sockets (230V), ventilation, shallow angle lighting, and controls are included.

Lighting and ventilation. Zen Pod is equipped with a uniquely designed knob for controlling both light and ventilation. The product has an energy-saving function that activates automatically after one hour without active input to the knob.

Offers even more privacy. Slatted panels are also available in clear-varnished oak or black-stained oak. Recessed curtain (sizes M, L, XL or XXL) of translucent fabric with a linen-like look also available.

Full accessibility. Ensure Zen Pod is available to all users by using a custom ramp. Please be aware that door adjustments may be necessary when a ramp is required.

Sustainability. Swedish Möbelfakta certified. The product is designed to be reused and comes with a 10-year replacement parts warranty.

Loose Furniture. Complete your Zen Pod interior by adding our furniture packages for meetings or focused work.



Clockwise L-R: Centre light and spotlights available; Optional slatted panels in clear-varnished oak; the uniquely designed knob for controlling both light and ventilation.

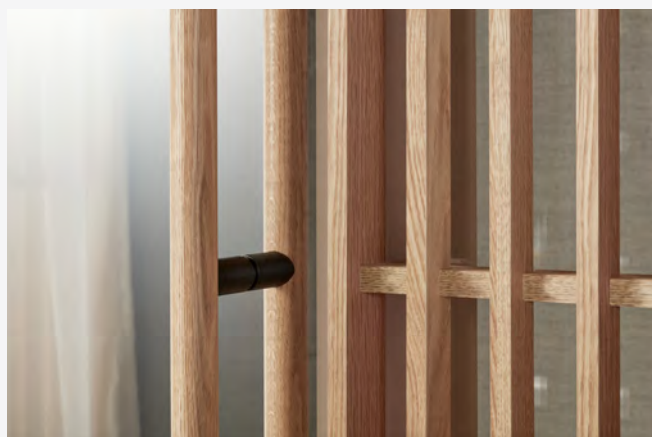

Zen Pod® Essential

- Painted black RAL 9005. Wood parts in black stained oak.
- Walls with Focus Melange, 6 standard colours.
- Dark grey floor carpet.
- Shallow-angle lighting and ventilation integrated into inner ceiling edge.
- Recessed curtain track.
- Can be mirrored left or right.

Large



2320x2320x2310 mm

.....

Small



1200x1200x2310 mm

.....

XL



3410x2320x2310 mm

.....

Medium



1200x2320x2310 mm

XXL



4515x2320x2310 mm

Zen Pod® Advanced

- Painted Nordic beige.
- Wood parts in clear varnished oak.
- Walls upholstered in Kvadrat Re-wool 128.
- Beige carpet, recessed curtain.
- Shallow-angle lighting and ventilation integrated into inner ceiling edge.
- Spotlights (sizes M, L, XL and XXL).
- Recessed curtain track.
- Can be mirrored left or right.

Large



2320x2320x2310 mm



Small



1200x1200x2310 mm



XL



3410x2320x2310 mm



Medium



1200x2320x2310 mm

XXL



4515x2320x2310 mm



CellPod by Senator

CellPod provides an excellent solution when creating privacy and collaboration spaces within work environments. They are designed as freestanding units and feature a structural framework with a demountable panel system so they are simple to install and reconfigure as needs change within an organisation.

“Powered by privacy.”

In addition to the standard configurations the CellPod system can be designed and manufactured to your own specification, providing unrivalled solutions for individuals to work in privacy and isolation through to comprehensive meeting room environments



CellPod features

STANDARD FEATURES

- Structural framework in standard EPC.
- Automated opening roof.
- Glazing panels, 10.8mm clear acoustic glass.
- Upholstered panels in Blazer, Blazer Lite or Synergy by Camira Fabrics.
- Integrated power -Twin power and twin USB A and C 30A.
- Single glazed Acoustic Aluminium framed door with drop seal.
- Ecophon acoustic ceiling.
- LED lighting system activated by PIR.
- Door handing and location to be specified.
- Air circulation system.

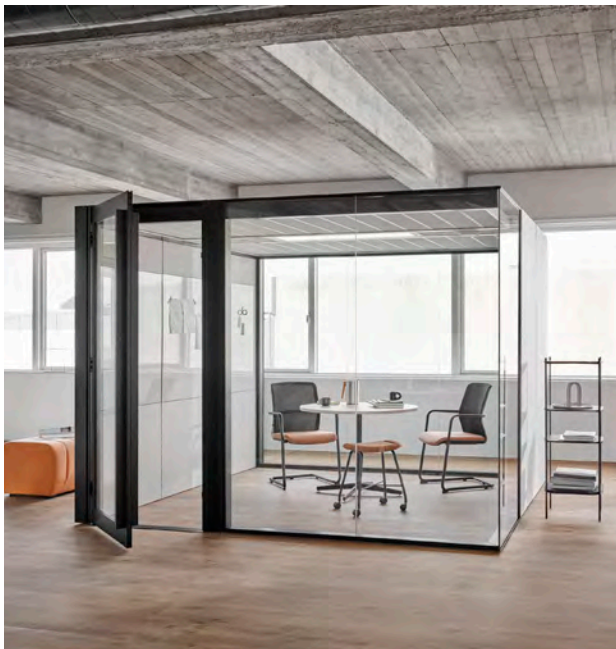

OPTIONAL FEATURES

- Sliding door.
- Dry wipe panel.
- Magnetic dry wipe panel.
- Back painted glass panels.
- Flat Screen/AV mounting support bracket and power module.
- Ceiling mounted comfort cooling unit.
- Power module bar to include 2 x power/USB/HDMI.

CellPod - CELLV2-01

Telephone Booth



OH: 2460mm | OW: 1140mm | OD: 1140mm

.....

CellPod - CELLV2-02

Study Booth



OH: 2460mm | OW: 1450mm | OD: 1140mm

.....

CellPod - CELLV2-03

Two Person Focus Cell



OH: 2460mm | OW: 2450mm | OD: 1410mm

.....

CellPod - CELLV2-04

Small Meeting Cell



OH: 2460mm | OW: 2450mm | OD: 1810mm

.....

CellPod - CELLV2-05

Four Person Cell



OH: 2460mm | OW: 3050mm | OD: 2850mm

CellPod - CELLV2-06

Six Person Cell



OH: 2460mm | OW: 4250mm | OD: 2850mm



cabana
by senator



Cabana by Senator

Defining space can be more than a room with a door, sometimes to make a space work you need to make it a destination, somewhere people go to get something done. Cabana is a modular demountable system that defines space.

“Cabana is an open structure that fosters seclusion and collaboration within working environments.”

As a modular system you can select what type of wall construction you want, each wall of Cabana can be different. The main extrusions are wrapped in an Oak foil to give a more custom-built look. Cabana can be specified with a closed acoustic ceiling with integrated lighting or with a slated upholstered fin ceiling.



Cabana Pod Overview

Moving away from your regular workstation to a defined space to have an impromptu meeting, share data on a media wall or sketch out a new idea with colleagues on a dry wipe wall. Cabana provides the space for this to happen, the fact you moved a short distance from your workstation to a different place gives your actions purpose and protects your colleagues from distraction allowing everyone to be more productive.

Cabana 3.0m x 3.0m

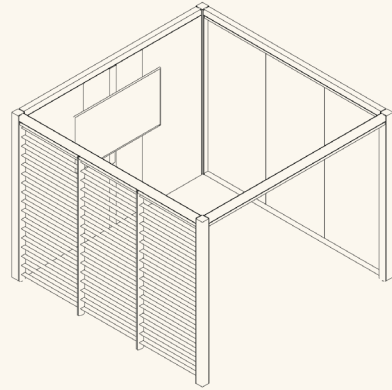

OH: 2300mm | OW: 3000mm | OD: 3000mm

Cabana 2.4m x 2.4m

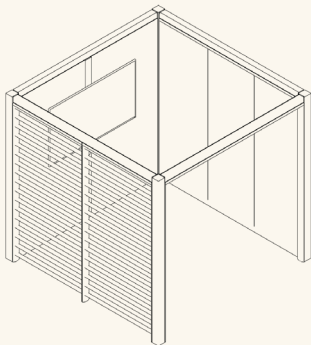

OH: 2300mm | OW: 2400mm | OD: 2400mm

Cabana 2.4m x 4.0m

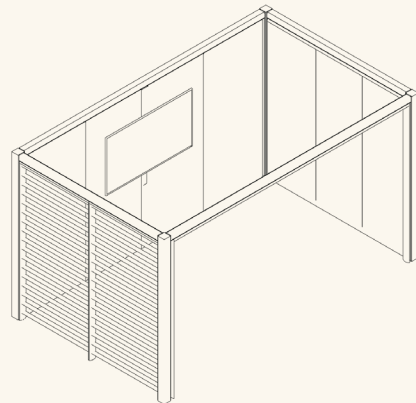

OH: 2300mm | OW: 4000mm | OD: 2400mm

Cabana 2.4m x 3.0m

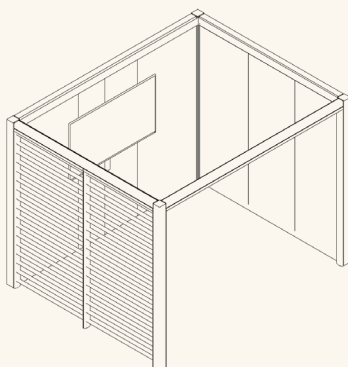

OH: 2300mm | OW: 2400mm | OD: 2400mm

Cabana 3.0m x 4.0m

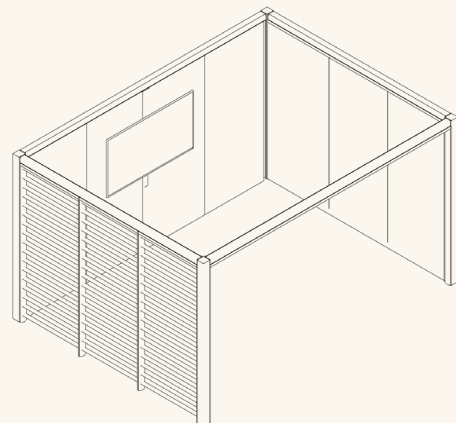

OH: 2300mm | OW: 3000mm | OD: 4000mm



Haven Pods

Advances in technology, changing work patterns and the trend towards open plan workspaces have resulted in an evolution of the modern workplace. Pods create both focused environments within open plan offices and provide ideal spaces for ad hoc meetings and sharing ideas.

“The variety of different pod sizes and shapes means you can meet together no matter what the size of your team.”

The products across the range offer different acoustic and privacy benefits. Their innovative geometric shape maximises space efficiency whilst also reducing surrounding noise.



Haven Pod features

STANDARD FEATURES

- Internal steel frame with multi-layered acoustic foam construction.
- Outer vertical panels upholstered in Camira Blazer fabric (two-tone is standard).
- Quick release panel connector system.
- Levelling adjusters.
- Integral work surface.*
- Integral work surface power and data module, incorporating; 1 x 3.15 amp power socket, powered USB and Cat 6 Data with 1.5m supply leads.*
- Work surface mounted power and data module, incorporating; 2 x 3.15 Amp power.*
- Integral under work surface vertical cable management.
- Fixed Worksurface with Cable Tray and Riser.*
- Low voltage LED task light.*



*Selected models only.



OPTIONAL FEATURES

- 1, 2, 3 or 4 person configuration.
- Height adjustable work surface.*
- Storage.
- Integral under work surface vertical cable management.
- Low voltage LED task light.
- Integral seat and backrest.
- Fixed worksurface with Cable Tray and Riser.*
- Multiple fabrics on integrated seat units.

Haven Pod Overview

The Haven Pods family consists of 6 variants. Haven Pods nestle and tessellate to maximise available space, allowing the creation of a community of environments and destinations.

This new family of Haven Pods has been developed to respond to what people tell us they want, to facilitate how people want and need to work; to focus as individuals or in group spaces.

Quad



OD: 2000mm
OW: 2000mm
OH: 1400-1800mm

Different specific sizes available

Solo



OD: 1700mm
OW: 1400mm
OH: 1400-1800mm

Different specific sizes available

Team Work

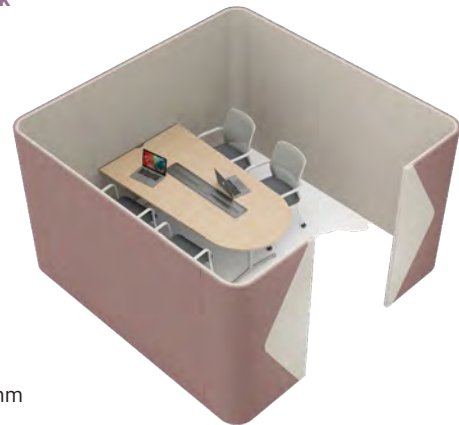

OH: 1800mm
OD: 3000mm
OW: 2500mm

Duo



OD: 2120mm
OW: 1000mm
OH: 1400-1800mm

Different specific sizes available

Team Meeting

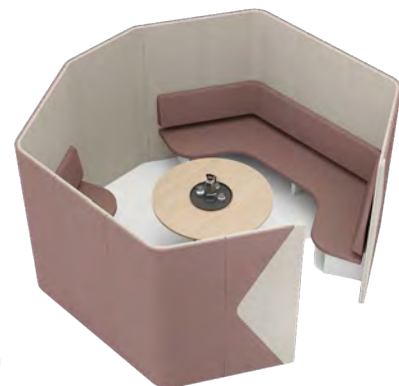

OD: 3200mm
OW: 3200mm
OH: 1800mm

Pods
by senator





Pods by Senator

The enhanced work surface size allows fixed pc's to be used and complies with legislation for use as a primary workspace.

FOCUS

Pods design and construction means you can focus on your work in a soft, acoustic setting, free from any distraction.

COLLABORATE

Work, relax and meet together in the privacy of a Pod. The variety of sizes of pods means you can get together to relax around a table as a team.



Pod features

STANDARD FEATURES

- Internal Steel frame with multi-layered acoustic foam construction.
- Outer vertical panels upholstered in Camira Blazer fabric (two-tone is standard).
- Quick release panel connector system levelling adjusters.

OPTIONAL FEATURES

- 1, 2, 3 or 4 person configuration.
- Height Adjustable Work Surface.*
- Storage.
- Fixed Worksurface with Cable Tray and Riser.*
- Multiple fabrics on integrated seat units.



*Selected models only.



ACCESSORIES

- Monitor Arms.
- PU Desk Accessories.
- Desk Top Accessories.
- CPU Holders.
- Electrical Accessories.
- Coat Hanger.
- Name Plate.
- A2 Magnetic Dry Wipe Board with hanger.
- A3 Magnetic Dry Wipe Board with hanger.

Solo Abode



W: 1500mm
D: 2000mm
H: 1400/1800mm

Duo Abode



W: 1500mm
D: 3500mm
H: 1800mm

2 Person Enclave



W: 2950mm
D: 1000mm
H: 1400/1800mm

4 Person Enclave



W: 2590mm
D: 1950mm
H: 1400/1800mm

Wall



D: 950mm
W: 3000mm
H: 1400/1800mm



Team Spaces



D: 2500mm
W: 4950mm
H: 1800mm



Quad Abode



W: 2950mm
D: 4450mm
H: 1800mm

Resource Corral

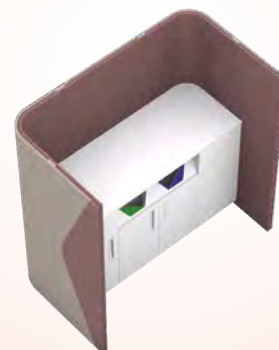

W: 1750mm
D: 1000mm
H: 1400/1800mm



Mote

Mote responds to the demands of dynamic work environments; versatile, reconfigurable spaces for meeting, learning, focusing, or relaxing. No detail is an afterthought with every inch having been given careful consideration to reclaim redundant space.

“Create modular spaces to meet and retreat with Mote.”

Meet at casual and open Mote configurations that use sofas and ottomans, or Retreat to more private and peaceful settings by erecting screens and canopies.





Meet

Whether you need somewhere to break out, meet up with your team or have a quick catch up, **Mote** can be configured in infinite ways to suit your size, space and needs.

Retreat

Sometimes we need a break from the bustle of a busy office. **Mote** uses additional screens and canopies to give you, your team and your conversations some privacy.



Mote features

STANDARD FEATURES

- Traditional carcass construction with multi density foam.
- Fully upholstered.
- Cast Aluminium frame.
- Plastic glides with levelling adjustment.

OPTIONAL FEATURES

- Frame fitted power units - 2 x powered.
- USB/TUF and 1x power socket.*
- Multiple fabrics.
- End arms.
- Single arms - mid.
- Double arms - intermediate.



Clockwise L-R: Two-tone upholstery is a popular feature of Mote; certain models of the range have a built-in work surface; Mote booths and sofas have the option to include power units.



Example 1.

This small configuration provides the right mix of privacy and freedom by utilising screens and ottomans.

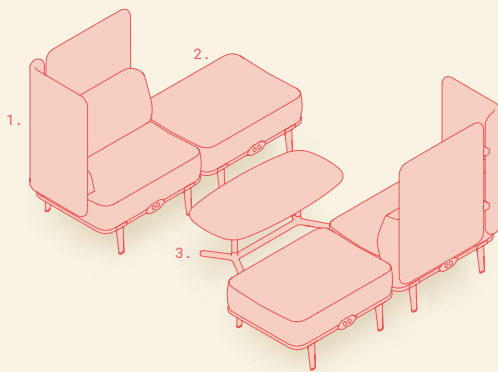

- 1. MTE-BCSL01
- 2. MTE-OT01
- 3. TAL22SR

Example 2.

An efficient and clean set up designed to create spaces for informal breakouts and dining.

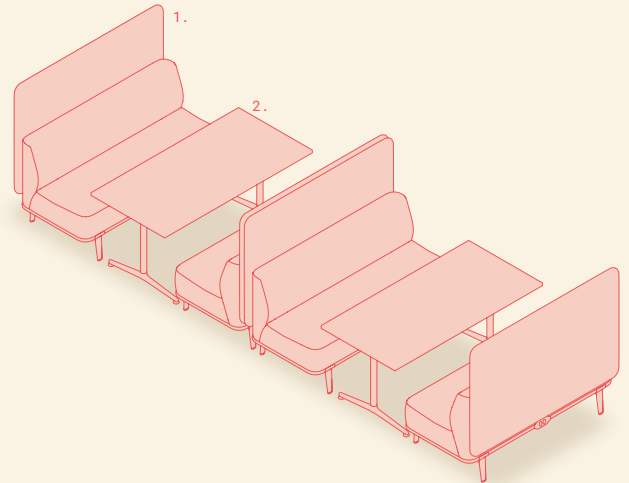

- 1. MTE-BSS90
- 2. ALP1608RC

Example 3.

A small setup which allows users to have a private catchup or meeting.

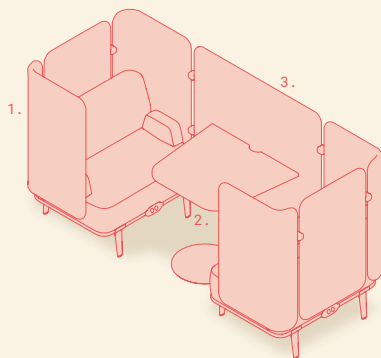

- 1. MTE-BSF01
- 2. MTE-MEDTB11
- 3. MTE-MED01

Example 4.

A hybrid setup of screened Mote sofas and agile Circo chairs, allowing for private ad-hoc meetings.

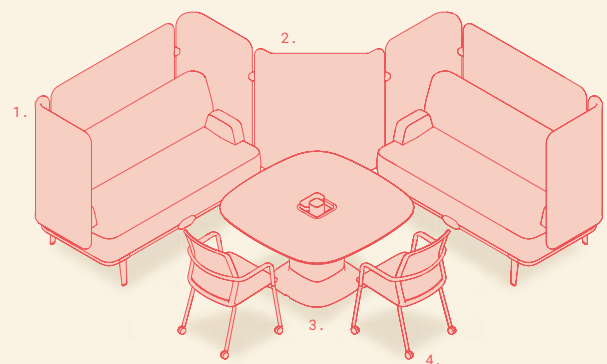

- 1. MTE-BSF02
- 2. MTE-BR90
- 3. FMGMT-1212
- 4. CR7



Hicks by Torasen

Introducing the ultimate seating booth designed for the modern office, where comfort, collaboration and productivity come together. Offering a versatile range of single seats and booths the curved aesthetic elevates the office environment.

STANDARD FEATURES

- Traditional carcass construction fully upholstered
- Fitted back and arm cushions
- Black Powder Coat legs

OPTIONAL FEATURES

- Castors
- Multi-Fabrics



HCS01



Overall Height: 1295mm Seat Width: 700mm
 Overall Width: 1100mm Seat Height: 460mm
 Overall Depth: 720mm Seat Depth: 515mm



HCS02



Overall Height: 1295mm Seat Width: 1474mm
 Overall Width: 1875mm Seat Height: 460mm
 Overall Depth: 720mm Seat Depth: 515mm



HCS12



Overall Height: 1295mm Seat Width: 700mm
 Overall Width: 2410mm Seat Height: 460mm
 Overall Depth: 1100mm Seat Depth: 515mm



HCS12T



Overall Height: 1295mm Seat Width: 700mm
 Overall Width: 2410mm Seat Height: 460mm
 Overall Depth: 1100mm Seat Depth: 515mm
 Table Length: 650mm



HCS14



Overall Height: 1295mm Seat Width: 1474mm
 Overall Width: 2410mm Seat Height: 460mm
 Overall Depth: 1875mm Seat Depth: 515mm

HCS14T



Overall Height: 1295mm Seat Width: 1474mm
 Overall Width: 2410mm Seat Height: 460mm
 Overall Depth: 1875mm Seat Depth: 515mm
 Table Length: 1250mm

Who we work with

We've collaborated with these great organisations.
We'd love to work with you next!



Our team

Backed by a team of over 20 professionals, these are just some of the friendly faces you'll see during a project.



David Cooke
Commercial Director

dcooke@officemaster.ie
086 2593 185



Dave McCarthy
Business Development Manager

dmccarthy@officemaster.ie
086 1452 774



Dawn Roberts
Business Development

droberts@officemaster.ie
086 3834 376



Patrick Murray
Business Development

pmurray@officemaster.ie
086 1364284

What we can do

Not just another furniture supplier, at OfficeMaster we can facilitate office furniture fitouts from conception to installation... and beyond.

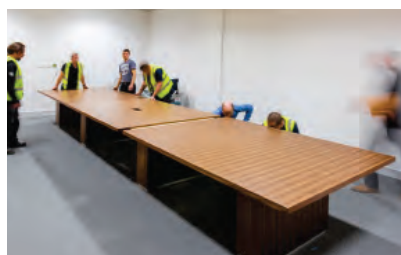

**CONSULTATION
& SPACE PLANNING**

**SUPPLY, DELIVERY
& INSTALLATION**

**POST PROJECT
SUPPORT**



office master

Work Happy

WATERFORD

93 Meaghers Quay
Waterford
X91 AVR7

(051) 876 995

CORK

Unit 42
Northpoint Business Park
New Mallow Road
Cork
T23 C9T0

(021) 2066 100

sales@officemaster.ie

www.officemaster.ie

