



Why Vaillant?

Because there's smart
and then there's vSMART



Visit [Plumb2u](#)

See product

The **USER** Guide

Allow me to introduce myself...

Saving energy has never been so easy. Designed to work harmoniously with all current Vaillant ecoTEC boilers, the vSMART's effortless connectivity ensures your boiler is working to its peak performance, always maintaining optimum efficiency. The Vaillant vSMART app allows you to take total control of your heating and hot water anytime, anywhere, from your smartphone or tablet. Featuring multiple tailored time and temperature profiles, the vSMART gives you the ability to schedule your home heating around your lifestyle.



What's in the box?

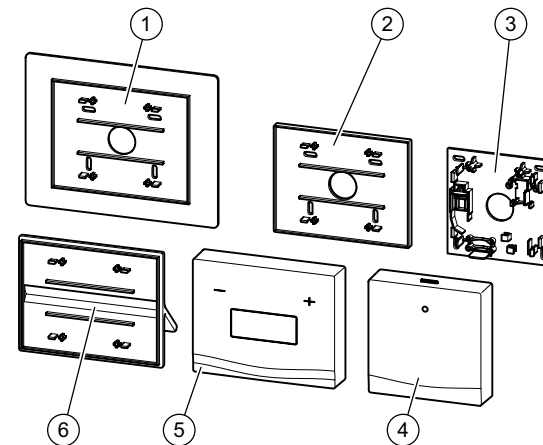

1. Wall bracket with trim plate
2. Flush wall bracket for thermostat
3. Flush wall bracket for gateway
4. Gateway communication unit
5. Thermostat
6. Table top stand

Visit [Plumb2u](https://www.plumb2u.com)

See product

Taking control of vSMART on the go

Once your vSMART control has been installed, you're ready to download the app.

Search for "vSMART" in the Apple App Store or Google Play to unlock your new generation of control from Vaillant.

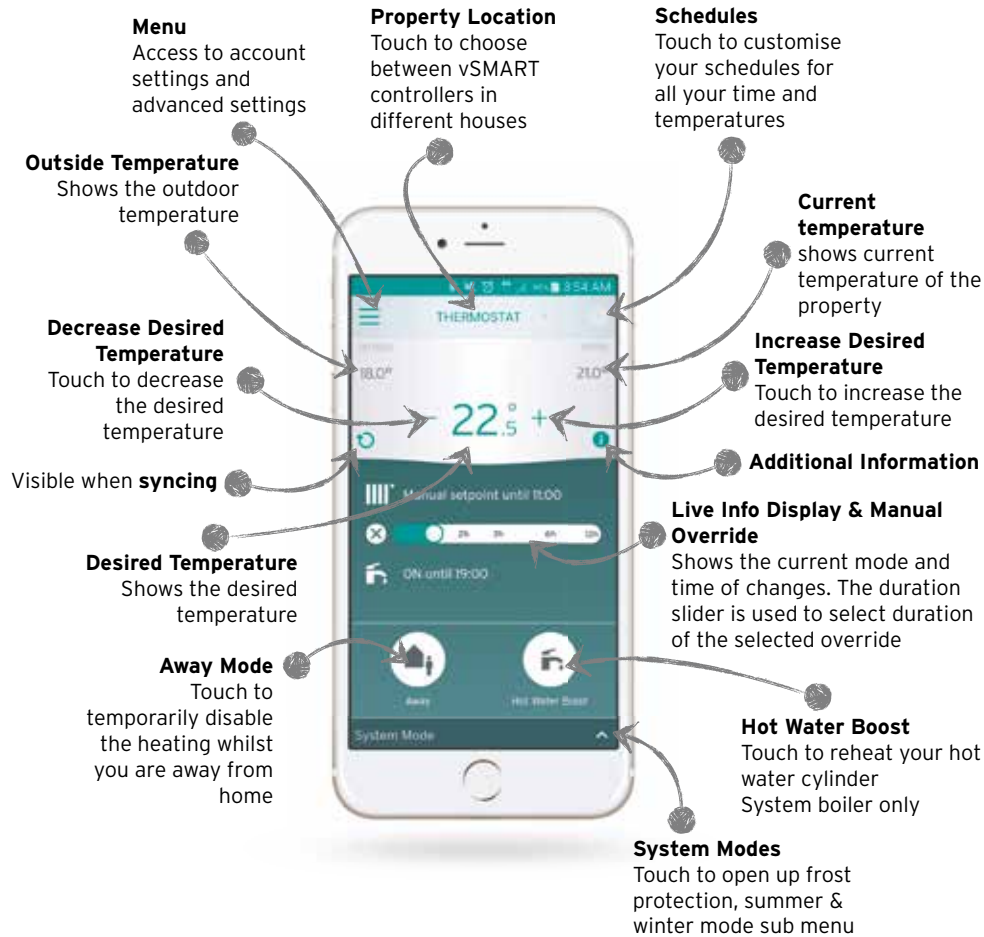

The App is available free of charge from Google Play and the Appstore. The App works on both smartphone or tablets and requires at least iOS 8.0 or Android 4.0

Taking control of vSMART with the intuitive interface

By simply pressing on the plus or minus button, you can set the desired room temperature, this will appear on the right. The bold temperature on the left is the current room temperature.

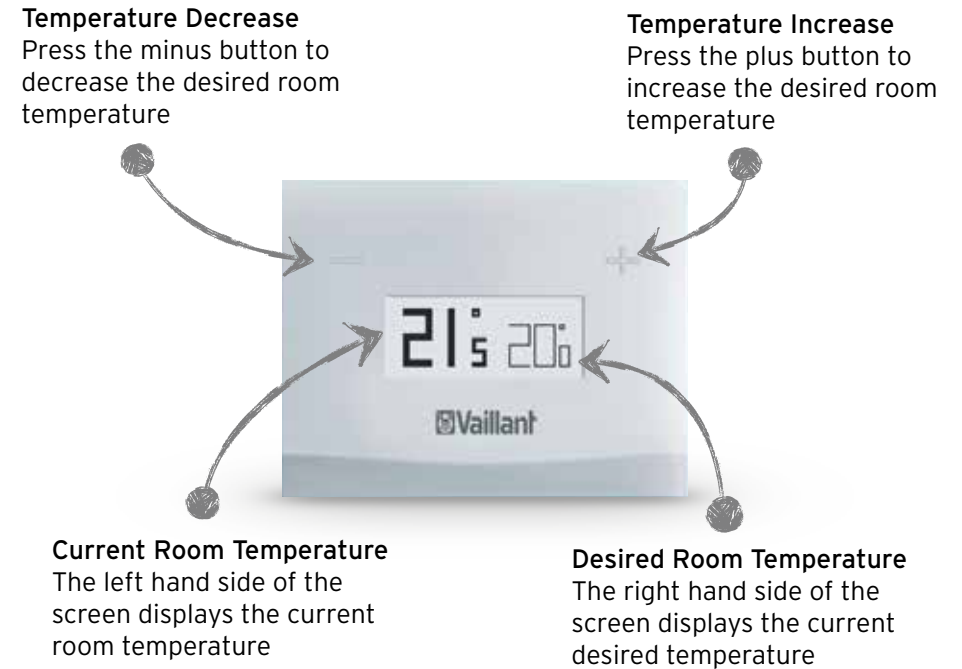

Visit **Plumb2u**

See product



Setting up time programs

Now you have downloaded the vSMART app and you have created an account. vSMART will ask you a number of questions about your lifestyle in order to create the perfect heating and hot water schedule for you.

What time do you wake up and go to sleep?

← The night

WAKING UP/SLEEPING

You wake up at:

07 h 00

You go to sleep at:

22 h 00

Next

When do you leave and come home?

← During the day

DURING WEEK DAYS

Do you stay home during the day? No

You leave home at:

08 h 00

You come back home at:

19 h 00

Next

Do you come home for lunch?

← Lunch

DURING WEEK DAYS

Do you come back home for lunch? Yes

Begin

12 h 00

End

13 h 30

Next

Are you at home on Saturdays?

← Saturday

SATURDAY

Do you want to schedule a time away from home on Saturday? No

Next

Are you at home on Sundays?

← Sunday

SUNDAY

Do you want to schedule a time away from home on Sunday? No

Next

What is your desired temperature?

← Temperature

COMFORT TEMPERATURE

What temperature do you want when you are at home?

- 20 + °C

For an optimal comfort, it is recommended to set this temperature around 20°C.

Next

Visit [Plumb2u](#)

See product

Temporarily overriding the temperature

From time to time you may want to manually override your heating set temperature, you can do this quickly and easily by following the steps below.

Did you know?
Turning down your room thermostat by just one degree could save between £85 and £90 a year.*



Choose your desired temperature
Touch the plus and minus to increase or reduce your desired temperature

Choose the duration
Touch and slide the slider until you reach the duration of time you require your new desired temperature to remain active

Cancel the override
At any point you can touch this icon to cancel the override, returning your heating system back to its program schedule

Going away? let your vSMART know



Away

Going on holiday? Let vSMART know by pressing the icon shown here. Let it know when you get back and it will make sure your home is ready for you when you return.

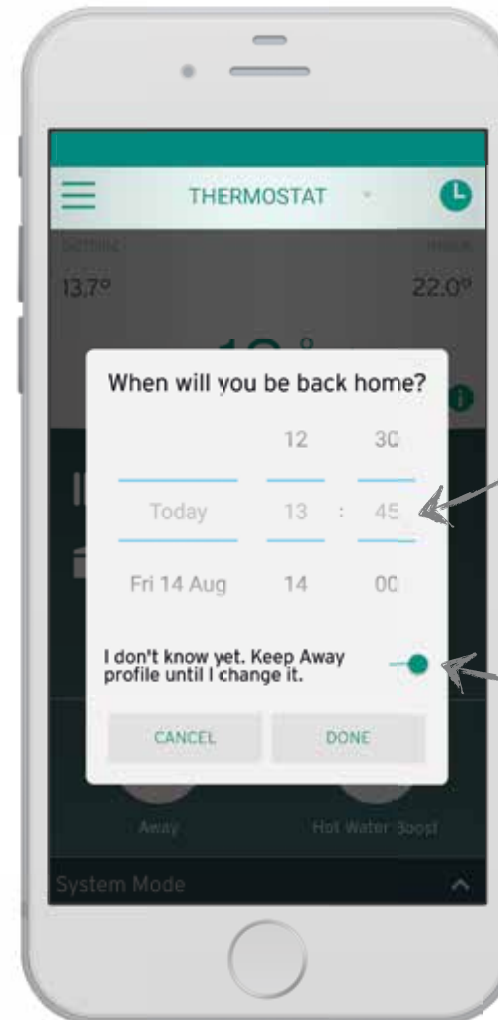

Choose the date you will be home
Choose a date when you will be back home

Don't know when you will be home?
Just click this switch and simply update it when you are on your way back to re-activate

* Energy Saving Trust - boiler control

Visit **Plumb2u**

See product

Using hot water boost

Need to give your hot water a quick boost? simply press the Hot Water Boost button on your app and the vSMART will tell your boiler to produce more hot water.



vSMART keeps you informed
vSMART will let you know what time the hot water boost will be fully completed

Hot Water Boost
Use this button to activate hot water boost, this will fully charge your hot water cylinder then deactivate automatically.

Changing your System Mode



Press the System Mode arrow in the bottom right hand corner of the display



Winter mode
Choose this mode during winter to activate both your heating and hot water schedule



Summer mode
Choose this mode during the warmer summer months when heating is not required. This mode will keep your heating off, whilst ensuring your hot water still follows your set schedule



Frost protection
Choosing this mode will ensure the boiler only comes on if the temperature in the property drops below 5°C

Visit **Plumb2u**

See product

Manually altering your heating and hot water schedule - week overview

Manually altering your heating and hot water schedule - add a heating period or profile

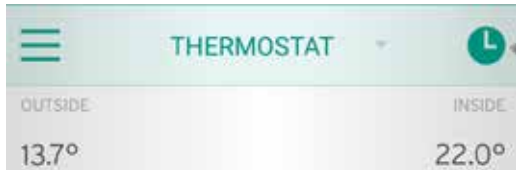

Press the clock symbol in the top right hand corner of the main display to access the screen below



Copy day
If you would like one day to mirror another, you can press the copy icon to then paste it onto another day



Paste day
Now, you have copied your desired settings, the remaining Copy icons will now change into a Paste icons. De-select the days you do not want to paste by pressing on the icon. Once you are happy with your settings, click done.

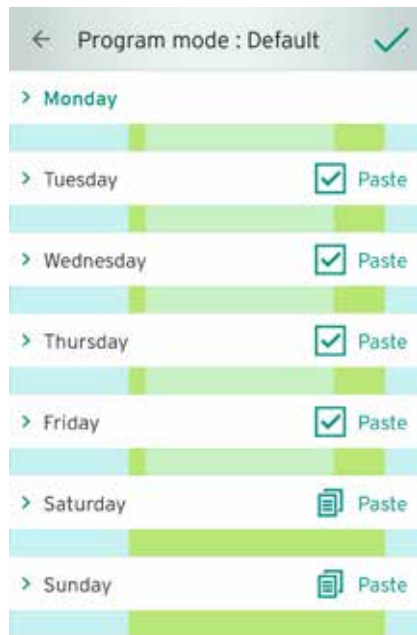

Choose the day you wish to edit

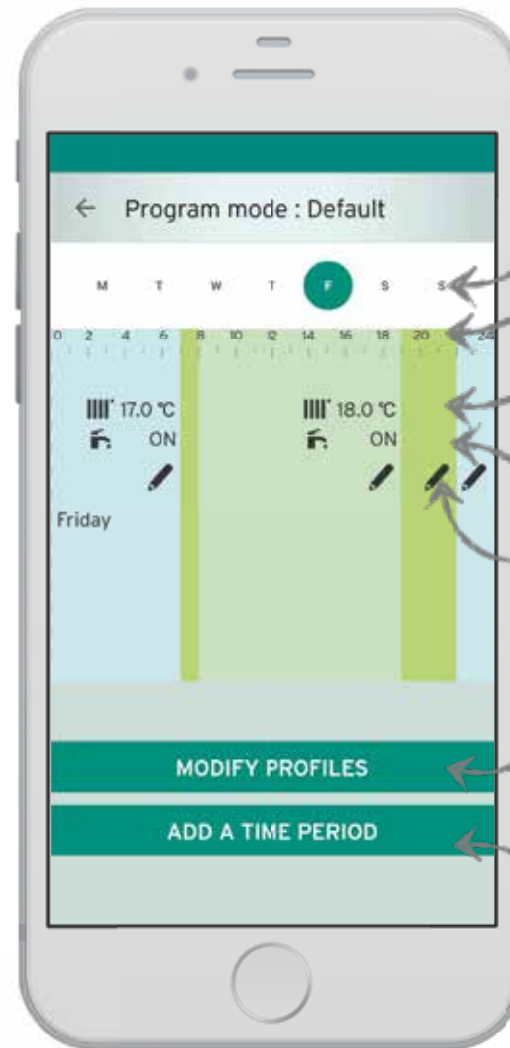

- Day Selection (Android only)**
Touch to choose which day you would like to edit
- Time Throughout The Day**
Scroll to change the time throughout the day
- Desired Heating Temperature**
Shows the desired heating temperature throughout the set time period
- Hot Water Mode**
Shows if the hot water is on or off during the set time period
- Edit Time Period**
Touch here to modify the time periods, desired room temperature and hot water mode
- Modify Profiles**
Touch here to see a display of all current profiles, (e.g. night, at home, away)
- Add a time period**
Touch here to add a time period, you can select a temperature profile or input your own temperatures

Visit **Plumb2u**

See product

Changing heating schedule



Add a time period
Touch here to add a time period, you can select a temperature profile or input your own temperatures

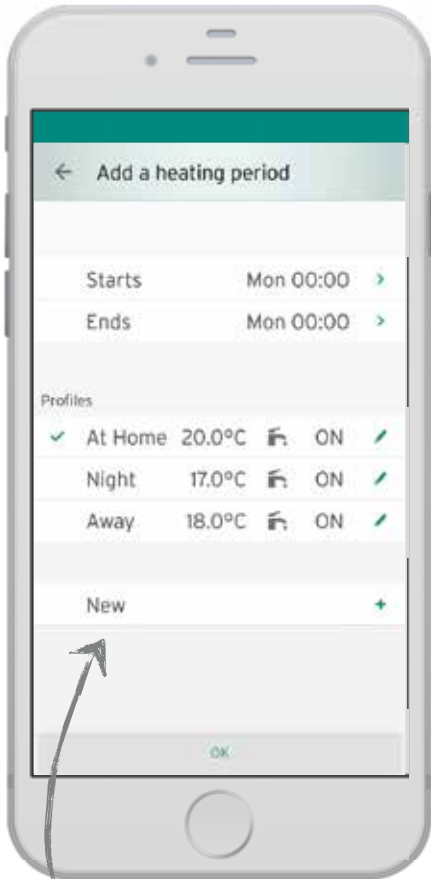

Choose start and end time
Choose the start and stop time for your new time period

Choose an existing profile
Choose from a previous profile you have set up or the profiles supplied with vSMART

Create a new profile
Choose this option to create a new profile you can use with this time profile. To create a profile you will need to choose a temperature, domestic hot water mode and then give it a name



Changing your settings



Press the menu icon to access the settings menu below

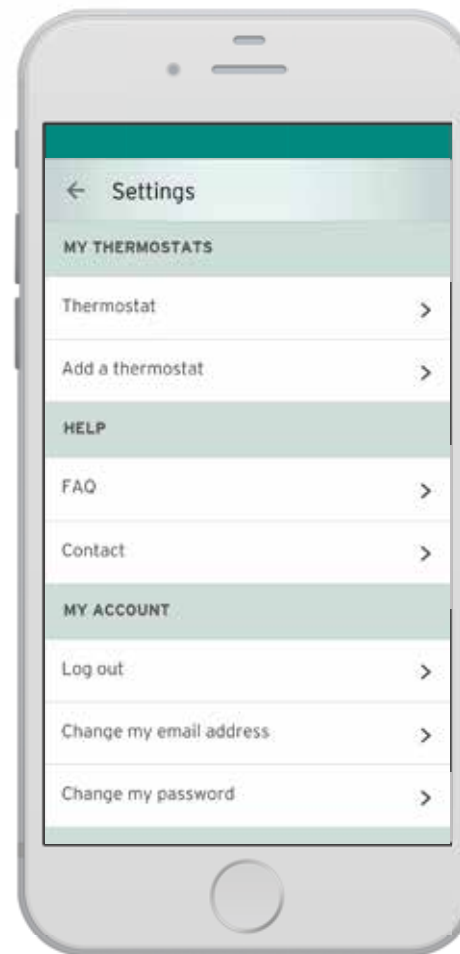

My Thermostats

This section is used to add new thermostats or access the settings of an existing thermostat

Help

This section provides you with useful FAQ's. If you are unable to find the answer to the question within the FAQ, you have the ability to contact Vaillant by pressing 'Contact'

My Account

In this section you can log out of the account you have signed into, change the email address assigned or change the password for the current account

Visit **Plumb2u**

See **product**

Thermostat settings



Press the menu icon to access the settings menu

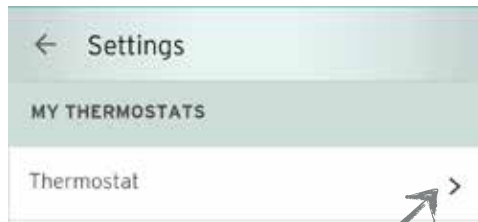

Choose the thermostat you wish to change settings for

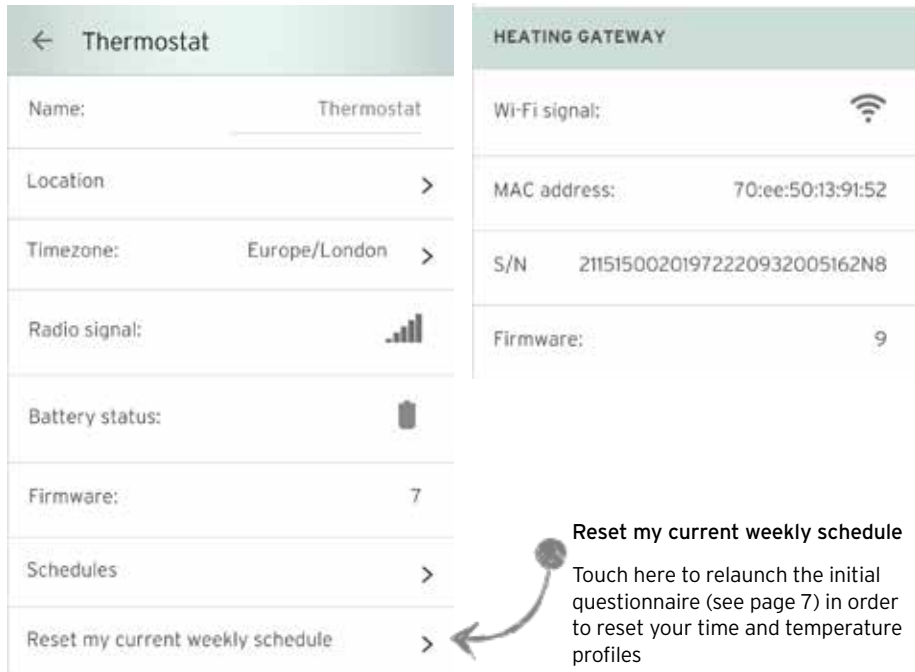

Reset my current weekly schedule
 Touch here to relaunch the initial questionnaire (see page 7) in order to reset your time and temperature profiles

Changing your batteries

Display shows:



1. Batteries are low, consider replacement



2. Batteries must be replaced

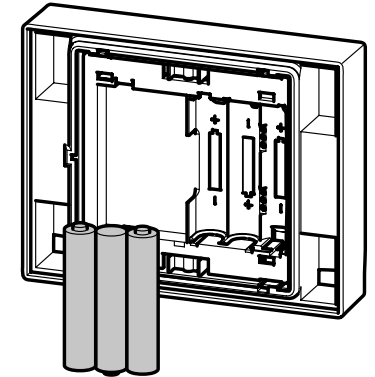

To replace the batteries

1. Remove the thermostat from the wall bracket or table stand.
2. Insert three new AAA alkaline 1.5 V batteries (these must all be identical and not rechargeable).
3. Place the thermostat back onto the wall bracket or table stand, you will hear the audible click as the thermostat is reattached.

Thermostat icons

Explanation of thermostat icons



Radio communication error

If this icon is displayed the thermostat is located too far from the gateway and will need positioning closer to the gateway



Pairing in progress

If this icon is displayed during initial setup, pairing is in progress

Visit **Plumb2u**

See product

Caring for vSMART

Clean the surface of the product with a damp cloth and a little solvent-free soap. Do not use sprays, scouring agents, detergents, solvents or cleaning agents that contain chlorine, this will damage the product materials.



[Visit Plumb2u](#)

[See product](#)

Training Enquiries

For information on training courses and centres in your area:

Telephone: 0345 601 8885

Sales Enquiries

For installers wishing to purchase Vaillant products, this is possible either over the counter or as a next day service at most plumbing and heating merchants in the UK.

To find contact details for your nearest Vaillant sales representative:

Telephone: 0345 602 0262

After Sales

For support after your boiler has been installed, whether you would like to book a service or are in need of technical advice, our operators are available 7 days a week, 364 days a year.

Telephone: 0330 100 3143

Technical Enquiries

For technical assistance:

Telephone: 0344 7360049

Email: technical@vaillant.co.uk

Visit [Plumb2u](#)

See [product](#)